

HYPERSN SmartV

Product Catalogue

Contents

HYPERVSN SmartV Solutions	3	SmartV Solo Accessories	13	SmartV Wall Accessories	22
HYPERVSN SmartV Solo M	4	HYPERVSN SmartV Tripod	15	HYPERVSN SmartV Frame	24
HYPERVSN SmartV Solo L	5	HYPERVSN SmartV Ceiling Mount	16	HYPERVSN SmartV Frame Extender	25
HYPERVSN SmartV Wall M	6	HYPERVSN SmartV Glass Box	17	HYPERVSN SmartV Glass Box L3	26
HYPERVSN SmartV Wall L	7	HYPERVSN SmartV Cube Regular	18	HYPERVSN SmartV Wall Portable HH	27
HYPERVSN SmartV Holographic Human	8	HYPERVSN SmartV Cube Shift	19	HYPERVSN SmartV Plex Guard 6	28
HYPERVSN SmartV Digital Avatar	9	HYPERVSN SmartV Dome	20	HYPERVSN SmartV Plex Guard 9	29
HYPERVSN SmartV 3D Modeller	10	HYPERVSN SmartV Dome Ultra	21	HYPERVSN SmartV Plex Guard 12	30
HYPERVSN SmartV 3D Catalogue	11			HYPERVSN SmartV Rack	31
HYPERVSN SmartV Slots	12				
				HYPERVSN SmartV Interactive Add-ons	32





HYPERVSN SmartV Solutions

HYPERVSN SmartV Solo M

An innovative solution to create, manage and display stunning high-definition detailed 2D and 3D content, which appears to be floating in mid-air. The single display is up to 56 cm / 22" in size and is managed easily with the HYPERVSN Software Suite.



Key features

-  Ultra-fine pixel pitch
-  Supports high-definition 2D and 3D content
-  Interactive capabilities
-  Lightweight and portable

Specifications

Hardware: HYPERVSN SmartV Display M, HYPERVSN SmartV Box1

Services: HYPERVSN SmartV Display Software Service M

Applications: HYPERVSN CMS and HYPERVSN App

Accessories: Tripod, Ceiling Mounts, Domes, Cubes

Add-ons: SmartV Pro (1 year, 3 year, Perpetual) subscriptions

Content: 3D Studio, Design Lab, Media Library, Use your own







HYPERVSN SmartV Solo L

A revolutionary solution to create, manage and display brilliant, bright 3D content, which appears to be floating in mid-air. The larger single display is up to 75 cm / 30" in size and is simply managed with the HYPERVSN Software Suite.



Key features

-  Brightness of 3000 Nits (outdoor)
-  Wide, accurate colour spectrum
-  Interactive capabilities
-  Larger display, perfect for viewing at a distance
-  Supports 3D and 2D content

Specifications

Hardware: HYPERVSN SmartV Display L, HYPERVSN SmartV Box1

Services: HYPERVSN SmartV Display Software Service L

Applications: HYPERVSN CMS and HYPERVSN App

Accessories: Tripod, Ceiling Mounts, Domes, Cubes

Add-ons: SmartV Pro (1 year, 3 year, Perpetual) subscriptions

Content: 3D Studio, Design Lab, Media Library, Use your own



HYPERVSN SmartV Wall M

A large-scale innovative solution to create, manage and display high-definition holographic 3D and 2D content in immaculate detail. This solution, made up of any number of single displays, can be easily installed, maintained and managed.

Key features



Flawless image quality

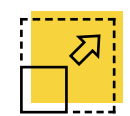

Large-scale and modular design



Display immaculate
2D & 3D content



Manage display and content
with ease

Specifications

Hardware: HYPERVSN SmartV Display M,
HYPERVSN SmartV Box 6/12

Services: HYPERVSN SmartV Display Software Service M
(per each display), SmartV Box 6/12 Software Service

Applications: HYPERVSN CMS, HYPERVSN App
and HYPERVSN Pro App

Accessories: Frame, Frame Extenders and Plex Guard





Content: 3D Studio, Design Lab, Media Library,
Use your own



HYPERVSN SmartV Wall L

An even larger-scale innovative solution to create, manage and display brilliant, bright holographic content with ease. The future of digital signage, HYPERVSN SmartV Wall, is made up of any number of single displays and can be seen from a large distance.

Key features

-  Brightness of 3000 Nits
-  Wide, accurate colour spectrum
-  Even Larger-scale and modular design
-  Visible from large distance
-  Supports 3D and 2D content

Specifications

Hardware: HYPERVSN SmartV Display L, HYPERVSN SmartV Box 6/12

Services: HYPERVSN SmartV Display Software Service L (per each display), SmartV Box 6/12 Software Service

Applications: HYPERVSN CMS, HYPERVSN App and HYPERVSN Pro App

Accessories: Frame, Frame Extenders and Plex Guard





Content: 3D Studio, Design Lab, Media Library, Use your own



HYPERVSN SmartV Holographic Human

HYPERVSN Holographic Human is an all-in-one solution to display life-size 3D humans to demo products, provide info or showcase the latest trends. It is made up of three HYPERVSN SmartV Solo L devices set-up in a vertical configuration and synchronized to display human-sized content. Connect with your audience on a more personal level using your brand ambassador, influencer or employee. Personify your brand and tell your brand story with the HYPERVSN Holographic Human.

Key features

-  Increase human connection
-  Revolutionize your display
-  Increase message retention
-  Personify your brand

Specifications

Hardware: HYPERVSN SmartV Display L × 3,
HYPERVSN SmartV Box 6

Services: HYPERVSN SmartV Display Software Service L
(per each display), SmartV Box 6 Software Service

Accessories: Alignment mounts / GlassBox L3 with Glass
(Regular or Antiglare) / Glass Box L3 (without glass)*

Add-ons: 3D Catalogue, SDK

Content: Design Lab, Use your own

* Note: glass is a necessity with the Glass Box L3 and this should be provided for installation.



HYPERVSN SmartV Digital Avatar

HYPERVSN holographic digital avatars are driving emotionally resonant and human-like experiences for customers, enabling you to enhance AI capabilities with the scalable “human touch”. Digital Avatar by HYPERVSN is a complex visual solution, based on Holographic Human, and enhanced by a Digital Avatar subscription and additional interactivity services.

Key features



Create engaging content easily

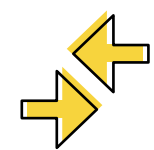

Create an impactful 2-way interaction



Use your chat-bots more effectively



Add the “human touch”

Specifications

Hardware: HYPERVSN SmartV Display L × 3, HYPERVSN SmartV Box 6

Services: HYPERVSN SmartV Display Software Service L (per each display), SmartV Box 6 Software Service, HYPERVSN SmartV Digital Avatar subscription (3-month, 1-year, 2-year, 5-year)

Additional parts: External PC, Monitor with touch-screen

Accessories: Alignment mounts / GlassBox L3 with Glass (Regular or Antiglare) / Glass Box L3 (without glass)*





* Note: glass is a necessity with the Glass Box L3 and this should be provided for installation.



HYPERVSN SmartV 3D Modeller

An interactive solution that allows a viewer to actively manipulate the 3D models with their hands. Now you can manipulate, rotate and display explosion* 3D models using a touchpad. 3D Modeller can be used as a visualisation tool for any 3D model be it in automotive industry, architecture or education. It can be used in retail to show parts of a product, explain a complex system in business, help with navigation at an event or used to enhance education in biology, history or art. 3D modeller allows to deliver powerful messages, pitch a product like a top-notch innovation, provide edutainment. Interactive holograms of the future are here.

Key features

-  Increase engagement
-  Improve understanding
-  Contact-free solution if required
-  Increases message retention

* Explosion (assemble/disassemble) feature available for all subscriptions as of Q3'22.

Specifications

Hardware: HYPERVSN SmartV Solo M/L or HYPERVSN SmartV Wall

Services: HYPERVSN SmartV Display Software Service M/L (per each display), SmartV Box 6/12 Software Service, HYPERVSN SmartV 3D Modeller Solo M/L 1 year subscription or HYPERVSN SmartV 3D Modeller Wall M/L 1 year subscription

Additional parts: External PC, Touchpad

Accessories: Tripod, Ceiling Mounts, Domes, Cubes, Frame, Frame Extenders and Plex Guard

Add-ons: Custom Content

Content: Design Lab, Use your own

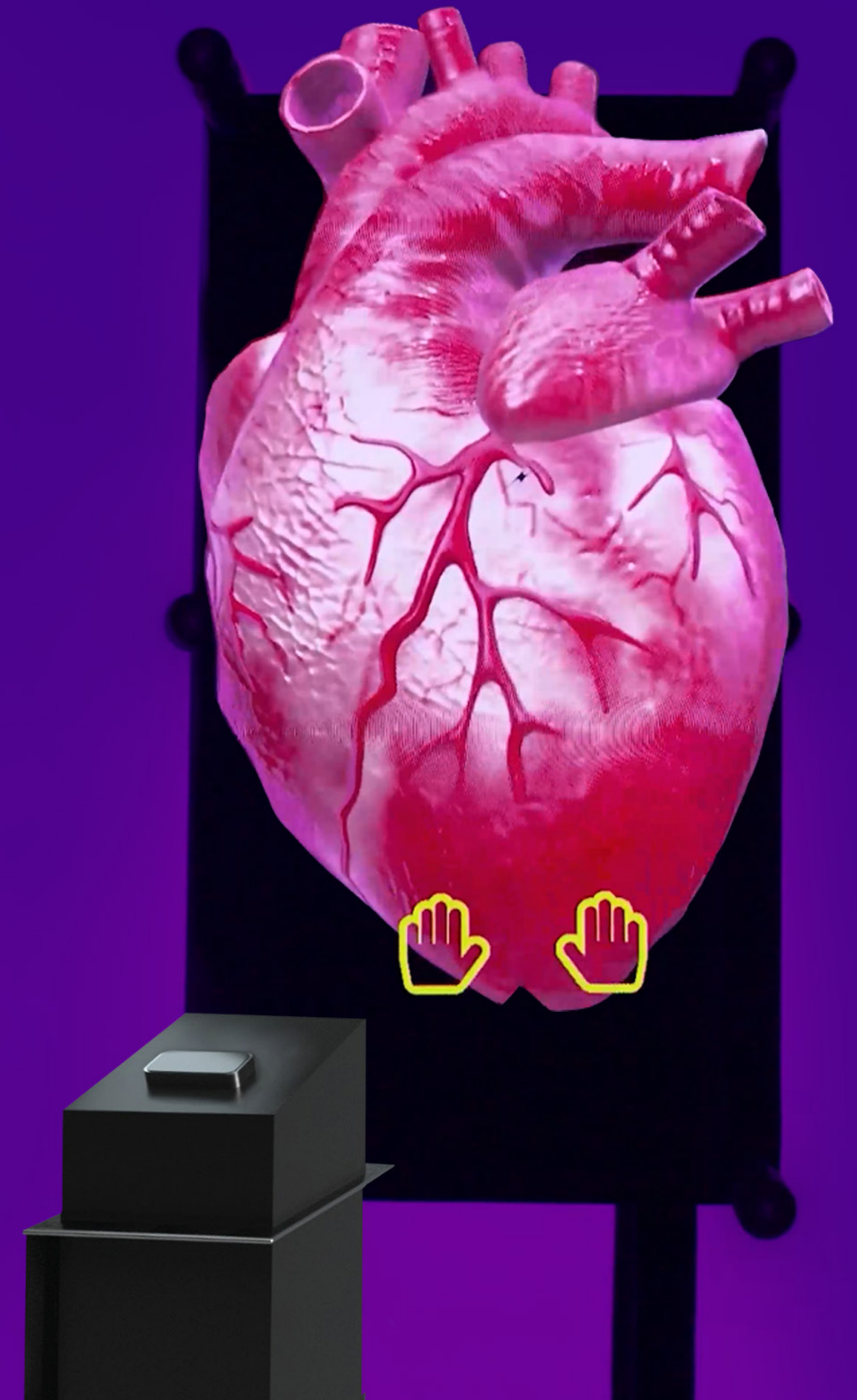

HYPERVSN SmartV 3D Catalogue

HYPERVSN SmartV 3D Catalogue is a complete, interactive technology solution, giving your audience the ability to virtually manipulate holographic images of your products with their hands! This solution is proven to increase engagement, sales and foot traffic all while creating a user experience that is innovative and unique resulting in insurmountable brand interactivity.

Key features



Increase sales with next level-engagement



Unparalleled user experience bringing the virtual into reality



Boost foot traffic with this eye-catching solution



Ensure your customers feel safe by installing contact-free technology*

* Contact-free only with Leap Motion Controller.

Specifications

Hardware: HYPERVSN SmartV Solo M/L or HYPERVSN SmartV Wall M/L

Services: HYPERVSN SmartV Display Software Service M/L (per each display), SmartV Box 6/12 Software Service, HYPERVSN SmartV 3D Catalogue Solo subscription or HYPERVSN SmartV 3D Catalogue Wall subscription

Additional parts: Tablet / PC + Leap Motion Controller

Accessories: Tripod, Ceiling Mounts, Domes, Cubes, Frame, Frame Extenders and Plex Guard

Add-ons: Custom Content

Content: Design Lab, Use your own

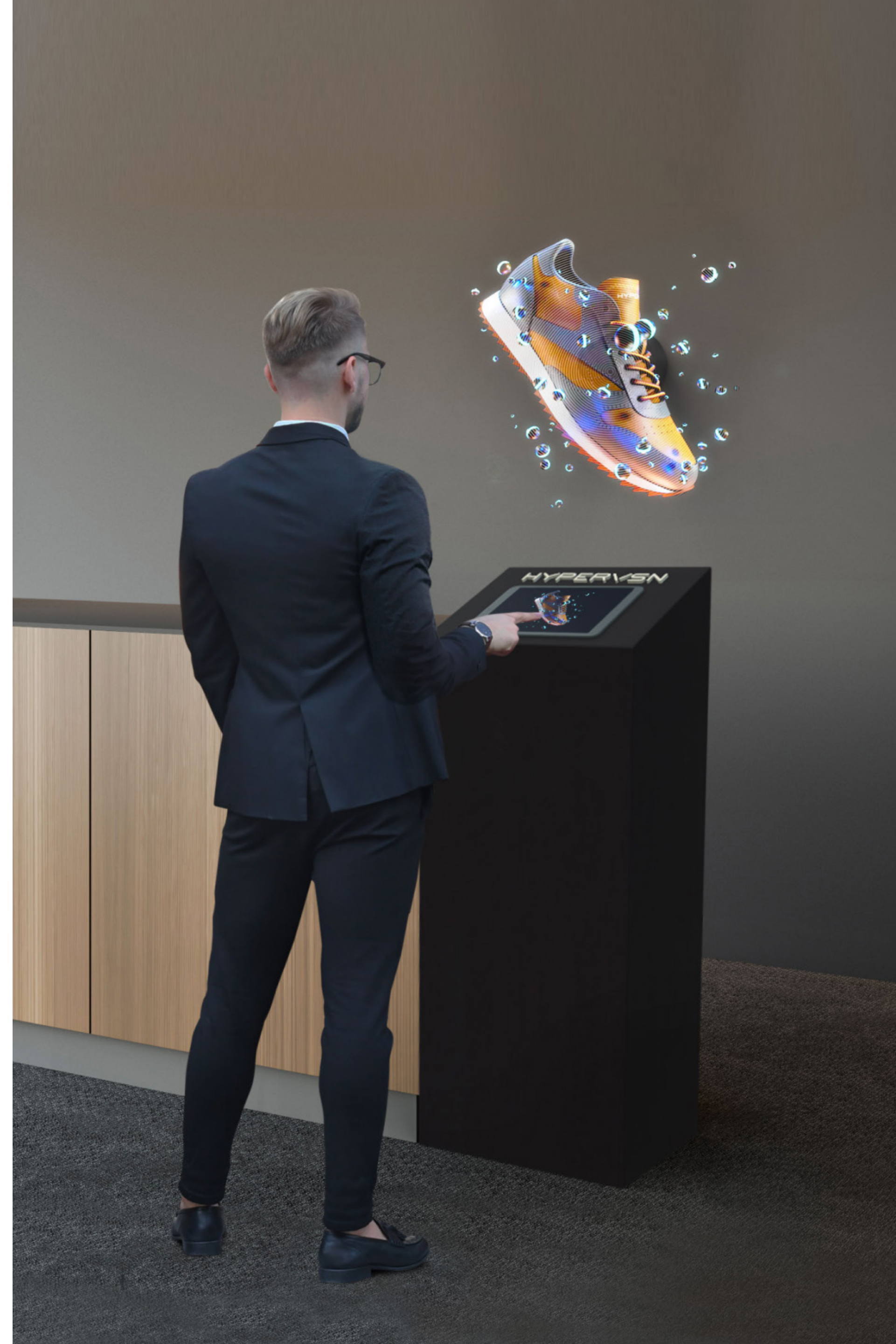

HYPERVSN SmartV Slots

HYPERVSN SmartV Slots is the world's first 3D holographic slot machine creating maximum excitement and engagement with your brand. Captivate audiences by giving them the chance to win by spinning the 3D slot machine. This innovative all-in-one solution takes experiential marketing to a new dimension. Create the ultimate brand experience that generates excitement, draws extensive crowds and promotes your brand with HYPERVSN SmartV Slots.

Key features

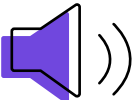
-  Boost audience participation
-  Ignite emotional response
-  Increase brand advocacy
-  Captivate viewers and increase foot traffic

Specifications

Hardware: HYPERVSN SmartV Display M/L × 3, HYPERVSN SmartV Box 6

Services: HYPERVSN SmartV Display Software Service M/L × 3 (per each display), SmartV Box 6 Software Service, HYPERVSN SmartV Slots Software Service

Additional parts: Button / Handle

Accessories: Tripods, Domes

Add-ons: Custom content

Content: HYPERVSN Slots Standard Content, Design Lab



SmartV Solo Accessories

SmartV Solo Accessories

With our range of SmartV Solo Accessories and installation solutions you can create the perfect holographic display in any environment. Designed to expand your installation opportunities and bring a new level of convenience and versatility to your set up. These accessories offer you everything from floor stands and ceiling mounts to portable solutions, and protective Domes and Cubes for various installations.



HYPERVSN SmartV Tripod

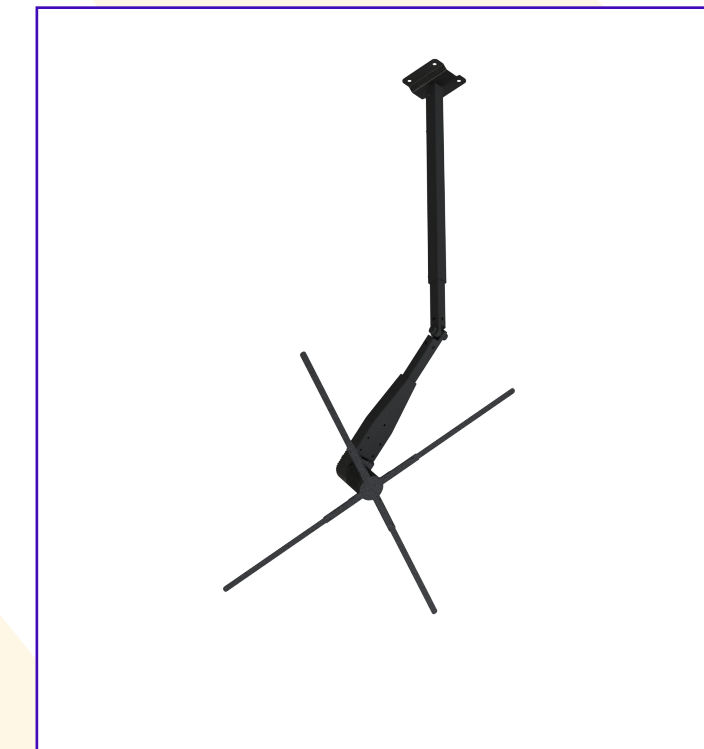

HYPERVSN SmartV Ceiling Mount

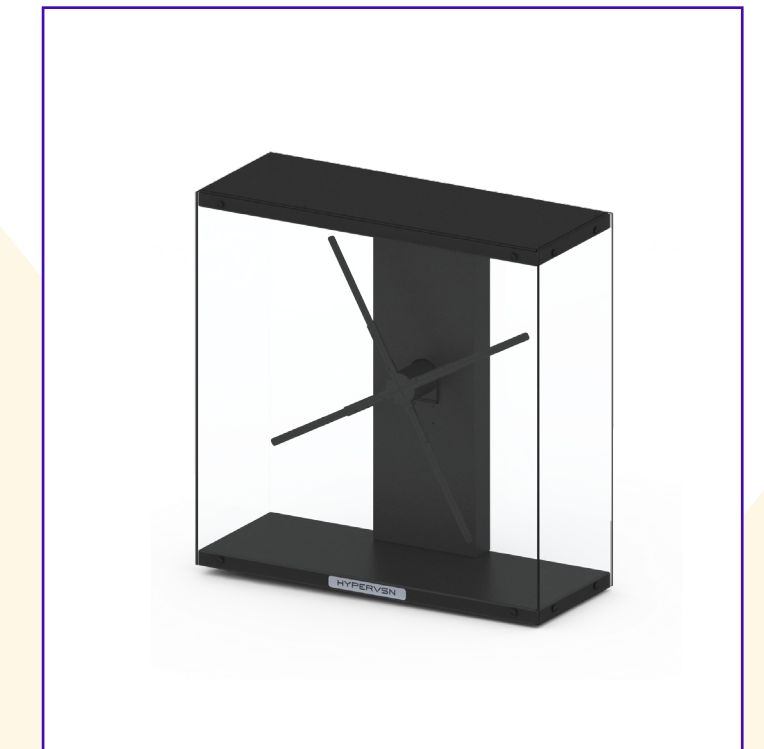

HYPERVSN SmartV Glass Box

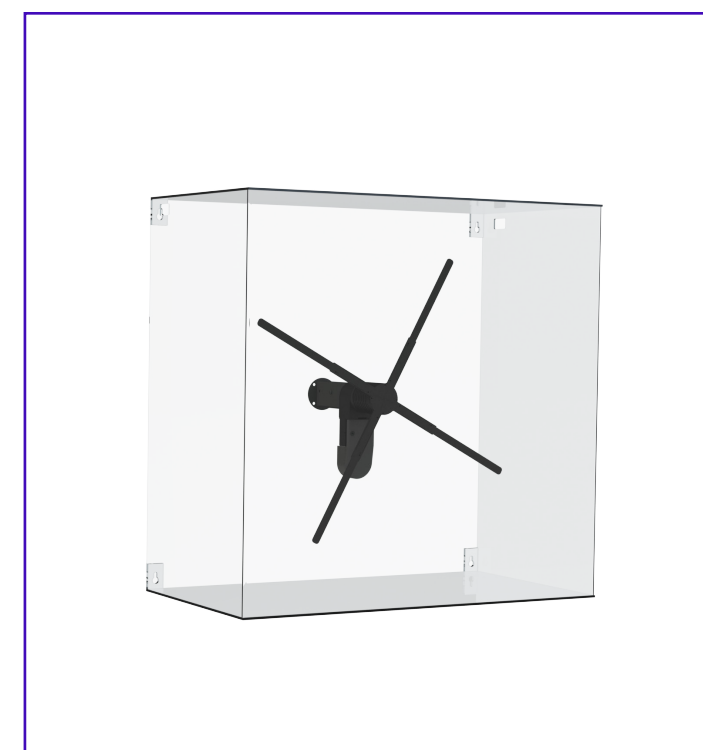

HYPERVSN SmartV Cube Regular

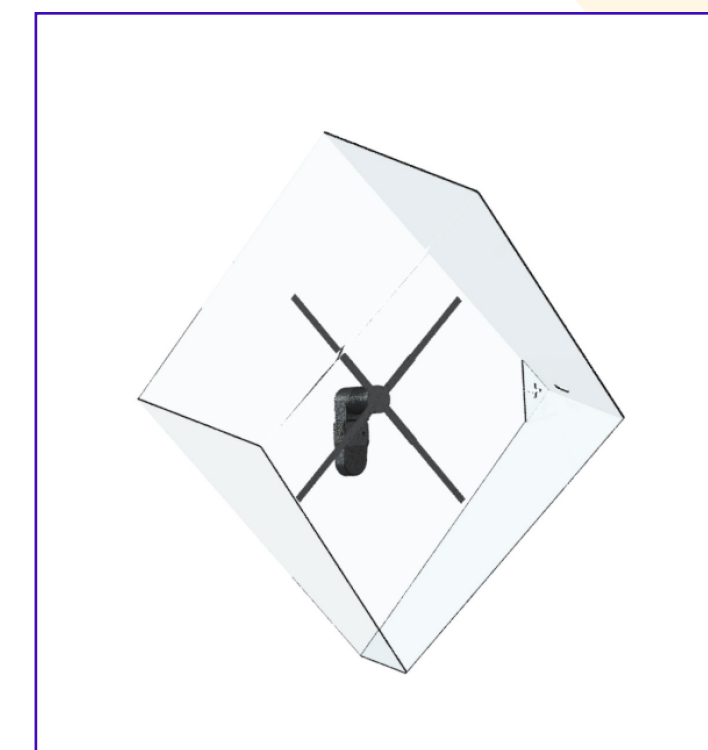

HYPERVSN SmartV Cube Shift



HYPERVSN SmartV Dome







HYPERVSN SmartV Dome Ultra

HYPERVSN SmartV Tripod

Elevate installations with the telescopic HYPERVSN SmartV Tripod, allowing single HYPERVSN SmartV Solo to be displayed at a height of 1.3 m – 2.2 m above the ground. SmartV Tripod is minimal in design and made with portability in mind with its lightweight construction. It can easily be transported, shipped, and is the perfect standalone installation solution for HYPERVSN SmartV Solo M and L. SmartV Tripod can be used in conjunction with HYPERVSN Domes.



Key features

-  Telescopic with adjustable height (1.3 m – 2.2 m)
-  Lightweight and highly portable
-  Quick installation and assembly
-  Perfect for product demos, meetings and events

Specifications

- Compatibility:** HYPERVSN SmartV Solo M and L
- Accessory compatibility:** HYPERVSN SmartV Dome M and L
- Weight:** 10 kg / 22 lbs (w/o display)
- Height:** 131 cm – 226 cm (w/o display)
- Base diameter:** 72 × 66 cm / 28.3 × 25.9”





HYPERVSN SmartV Ceiling Mount

Suspend HYPERVSN SmartV Solo display from the ceiling and create the perfect high-visibility solution for audiences. HYPERVSN SmartV Ceiling Mount, with its telescopic, lightweight construction, is easy to install and allows users to adjust its height and angle of inclination. This accessory can be easily shipped and is compatible with HYPERVSN Domes. Redefine traditional installations by seizing the largest unoccupied activation area available – overhead space.

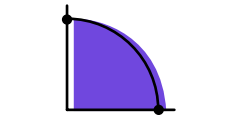

Key features

-  Increases device impact over distance
-  Adjustable height and device angle
-  Lightweight and easy to install
-  Perfect for retail, hospitality or corporate spaces

Specifications

Compatibility: HYPERVSN SmartV Solo M and L

Accessory compatibility: HYPERVSN SmartV Dome M and L

Weight: 3 kg / 6.6 lbs (w/o display)

Length: 101 cm – 136 cm / 39.7” – 53.5” (w/o display)



HYPERVSN SmartV Glass Box

Robust and elegant, the protective HYPERVSN SmartV Glass Box is minimal in design with antiglare front glass, transparent side walls, and dark top and bottom surfaces. The background enhances the 3D visual effects, while the antiglare front glass allows for minimal image distortion. This makes it the ideal installation display for shop-front tables, bar counters and any other flat horizontal surfaces.



Key features

-  Antiglare front glass with minimal image distortion
-  Increased brightness and scratch resistance
-  Portable, lightweight and provides protection
-  Perfect for retail, bars and receptions

Specifications

HYPERVSN SmartV Glass Box M

Compatibility: HYPERVSN SmartV Solo M

Weight: 24 kg / 52.9 lbs (w/o display)

Dimensions: 66.5 cm × 66.5 cm × 30 cm /
26.2" × 26.2" × 11.8"

HYPERVSN SmartV Glass Box L

Compatibility: HYPERVSN SmartV Solo L

Weight: 35 kg / 77.2 lbs (w/o display)

Dimensions: 91.8 cm × 86.1 cm × 30.7 cm /
36.1" × 33.9" × 12.1"





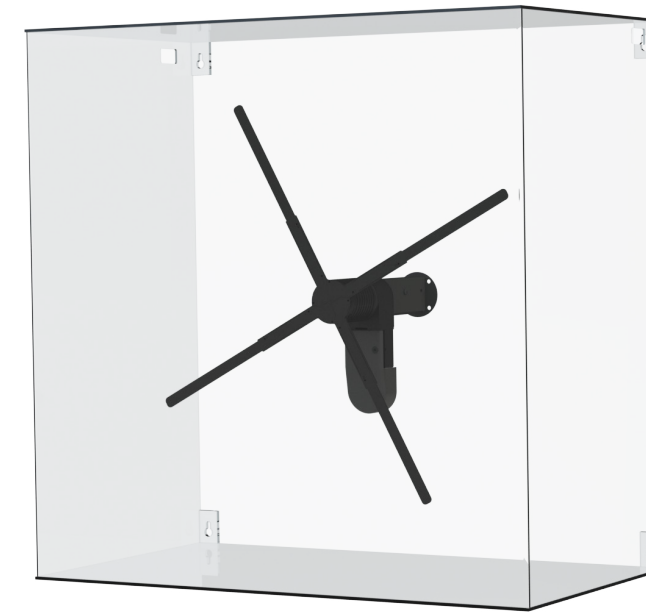

HYPERVSN SmartV Cube Regular

Install HYPERVSN SmartV Solo M on a horizontal surface like a wall within a protective enclosed transparent cube. This is the perfect solution for permanent installations and allows for the display to be at eye level within audience reach. Bring a 3D element to life on a flat vertical surface and enhance the holographic effect of the HYPERVSN SmartV Solo. HYPERVSN SmartV Cube Regular is perfect for retail walls, lobbies, meeting rooms, behind a bar counter or on any wall where you want to grab attention.



Key features

-  Minimalistic design to enhance 3D effect
-  Protect your display in high traffic areas
-  Bring 3D element to a Flat vertical surface
-  Perfect for retail walls, lobbies, meeting rooms, or any wall

Specifications

HYPERVSN SmartV Cube Regular M

Compatibility: HYPERVSN SmartV Solo M

Weight: 6 kg / 13.2 lbs (w/o display)

Length: 70 cm × 70 cm × 39 cm /
27.5" × 27.5" × 15.3"

HYPERVSN SmartV Cube Regular L

Compatibility: HYPERVSN SmartV Solo L and M

Weight: 10 kg / 22 lbs (w/o display)

Length: 91 cm × 91 cm × 45 cm /
35.8" × 35.8" × 17.7"





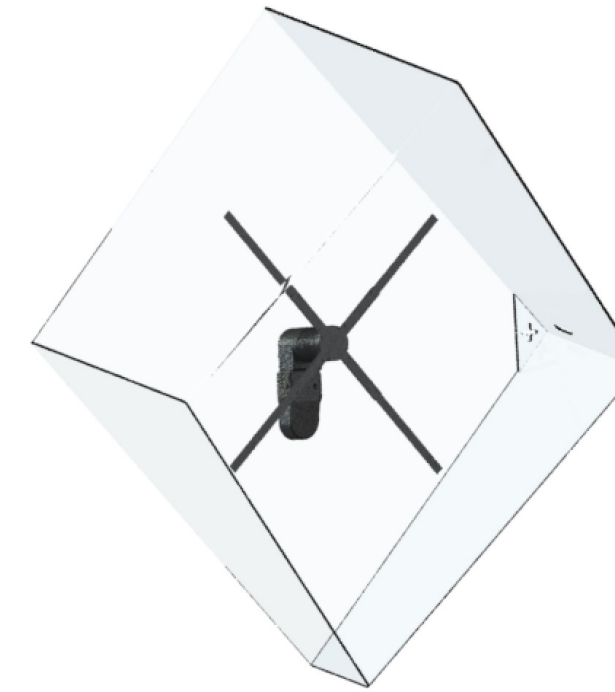

HYPERVSN SmartV Cube Shift

Create interest and draw audience attention with HYPERVSN SmartV Cube Shift. This installation solution is brilliant when mounting HYPERVSN SmartV Solo M or L high on a wall allowing for better visibility from below with the inclination angle of the front side. The cube is completely transparent, except for the side mounted on the wall, allowing the 3D display to captivate the viewer, and be seen at a distance, across the room. Astonish your audience with HYPERVSN SmartV Cube Shift.



Key features

-  Draws attention
-  Enhances the 3D Effect
-  Protect your display in high traffic areas
-  Perfect for elevated installations

Specifications

HYPERVSN SmartV Cube Shift M

Compatibility: HYPERVSN SmartV Solo M

Weight: 6 kg / 13.2 lbs (w/o display)

Length: 70 cm × 70 cm × 45 cm /
27.5" × 27.5" × 17.7"

HYPERVSN SmartV Cube Shift L

Compatibility: HYPERVSN SmartV Solo L and M

Weight: 9 kg / 19.8 lbs (w/o display)

Length: 91 cm × 91 cm × 45 cm /
35.8" × 35.8" × 17.7"







HYPERVSN SmartV Dome

Explore new installation opportunities with the HYPERVSN SmartV Dome. This accessory safeguards HYPERVSN SmartV Solo M (56 cm) or L (75 cm) displays in a protective transparent shield, allowing devices to be placed within reach of audiences. HYPERVSN SmartV Dome is easy to mount and the minimalistic design draws the viewers' attention to the display without detracting from the holographic effect.



Key features

-  Minimalistic design
-  Safer for installations within audience reach
-  Scratch and damage resistant
-  Easy to mount or use in conjunction with other accessories

Specifications

Accessory compatibility: HYPERVSN SmartV Ceiling Mount and HYPERVSN SmartV Tripod

Thickness: 4 mm / 0.16"

HYPERVSN SmartV Dome M

Compatibility: HYPERVSN SmartV Solo M

Weight: 6.5 kg / 14.3 lbs (w/o display)

Dimensions: 76 cm / 29.9". **Depth to surface:** 38 cm / 14.96"

HYPERVSN SmartV Dome L

Compatibility: HYPERVSN SmartV Solo L and M

Weight: 10.5 kg / 23.1 lbs (w/o display)

Diameter: 98 cm / 38.6". **Depth to surface:** 48 cm / 18.9"







HYPERVSN SmartV Dome Ultra

HYPERVSN SmartV Dome Ultra is sleek, yet grand in design. It creates the impression of an enhanced 3D effect, and the visuals displayed within appear to be enlarged (to the human eye). This transparent shield only sits 27 cm off any installation Wall – making it fit easily into almost any interior space as a fixed installation.



Key features

-  Premium Minimalistic design
-  Creates the impression of an enhanced 3D effect
-  Visuals displayed appear enlarged
-  Design protects devices while enhancing interior spaces

Specifications

Compatibility: HYPERVSN SmartV Solo L and M

Weight: 10.5 kg / 23.1 lbs (w/o display)

Diameter: 137.5 cm / 54.1”

Thickness: 4 mm / 0.16”

Depth to surface: 39 cm / 15.6”



SmartV Wall Accessories

SmartV Wall Accessories

Unlock the full potential of HYPERVSN Wall with this custom range of Wall accessories. Whether you are looking for a protective screen, an alternative mounting solution or just a quicker way to install the Wall, these accessories will provide everything you need to complete your installation with ease. Bring a new level of convenience and versatility to your set up without compromising your audience's viewing experience.

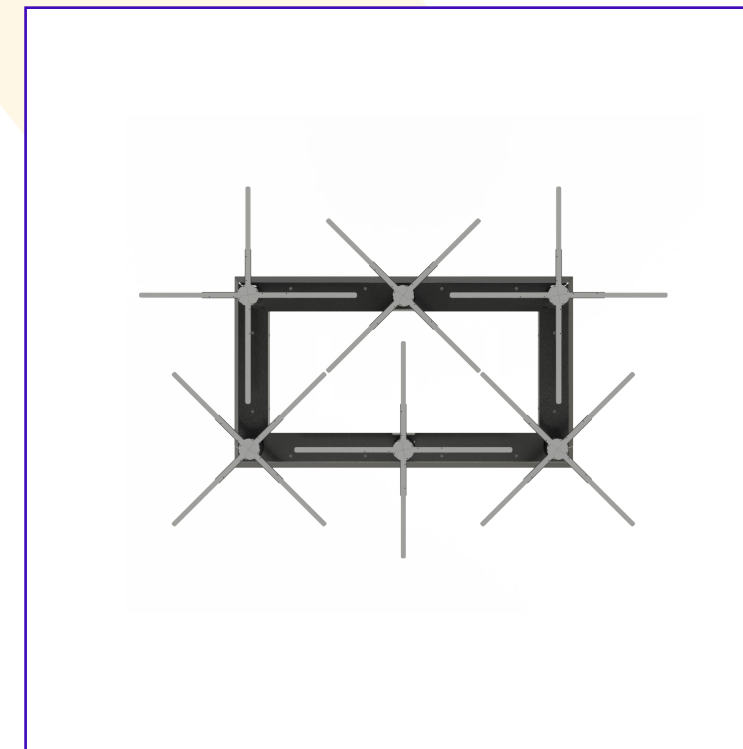

HYPERVSN SmartV Frame



HYPERVSN SmartV Frame Extender



HYPERVSN SmartV Glass Box L3



HYPERVSN SmartV Wall portable HH

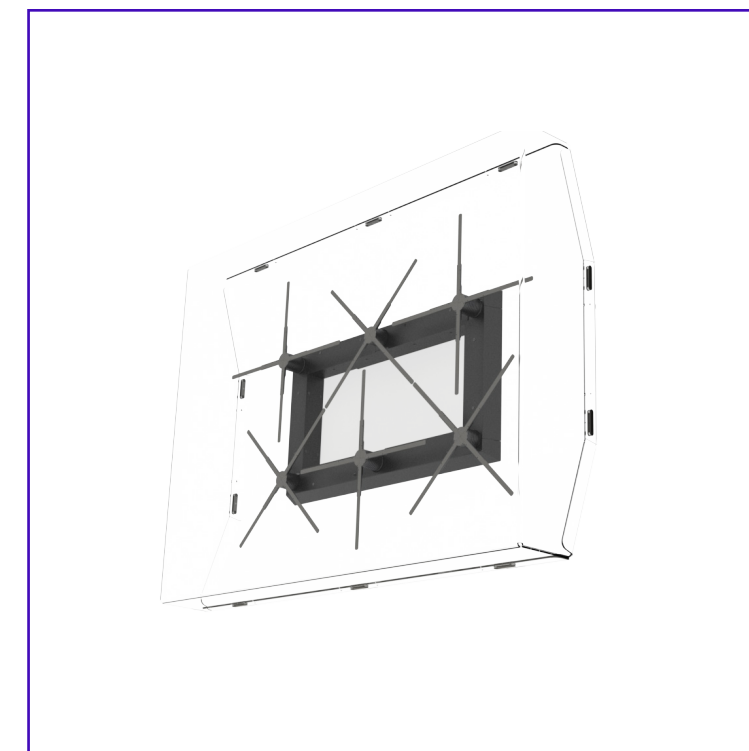

HYPERVSN SmartV Plex Guard 6

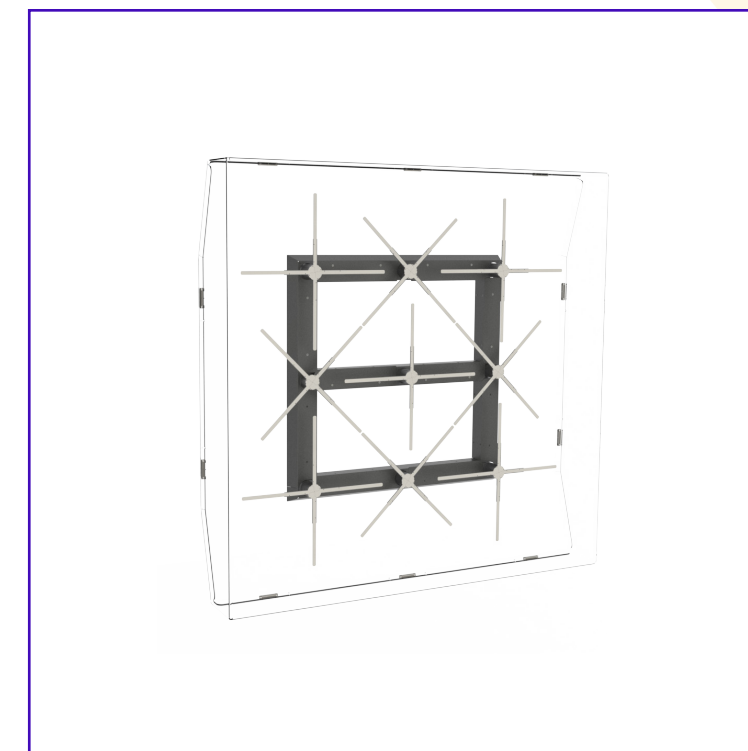

HYPERVSN SmartV Plex Guard 9

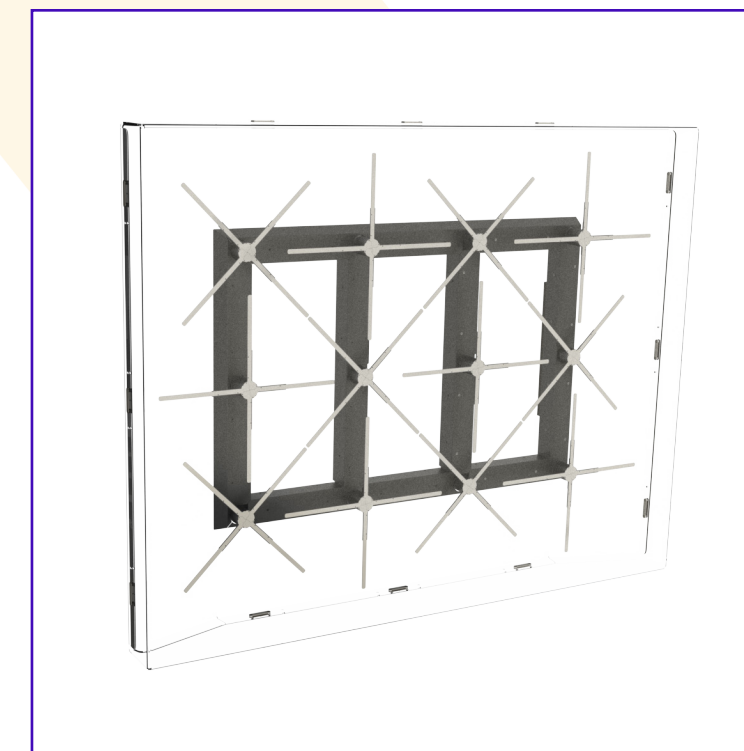

HYPERVSN SmartV Plex Guard 12

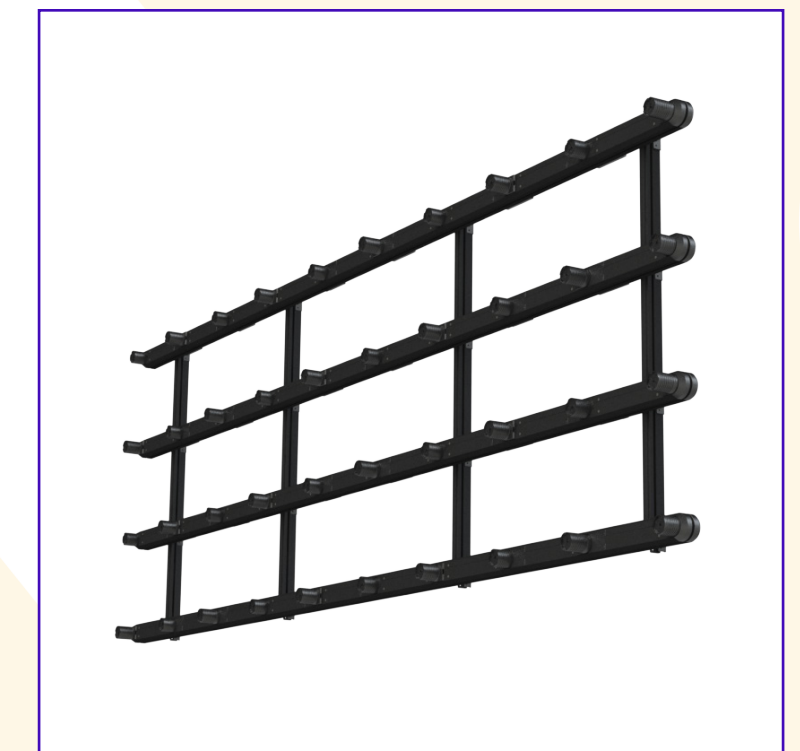



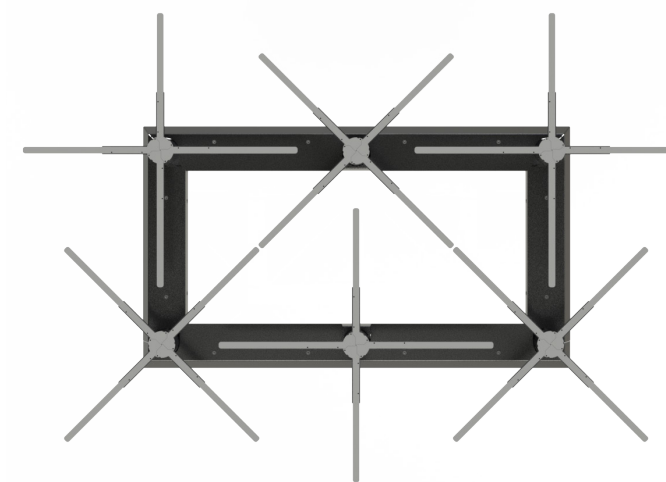

HYPERVSN SmartV Rack

HYPERVSN SmartV Frame

HYPERVSN SmartV Frame is an integral part of HYPERVSN SmartV Wall and comes in both M and L sizes, providing the sturdy framework that creates the Wall. This fundamental installation structure provides the perfect spacing and alignment needed to easily install a Wall. It is modular in design and can be scaled with the HYPERVSN SmartV Frame Extender. It is made with high quality, durable material ensuring HYPERVSN SmartV Wall M and L can be maintained with ease.



Key benefits

-  Integral framework of HYPERVSN SmartV Wall M and L
-  Install, scale, and maintain with ease
-  Vertical and horizontal installation
-  Compatible with universal VESA mounts

Specifications

Compatibility: HYPERVSN SmartV Wall M/L

Accessory compatibility: HYPERVSN SmartV Extender M/L and HYPERVSN SmartV Plex Guard M/L (6/9/12)

HYPERVSN SmartV Frame M

Weight: 17.5 kg / 38.5 lbs (w/o displays)

Dimensions: 92 cm × 52 cm × 12 cm / 36.2" × 20.5" × 4.7"

HYPERVSN SmartV Frame L

Weight: 27 kg / 23.1 lbs (w/o displays)

Dimensions: 118 cm × 65 cm × 18 cm / 46.5" × 25.6" × 7.1"



HYPERVSN SmartV Frame Extender

This installation accessory is modular in design, allowing for Walls of any size and configuration to be easily created. One HYPERVSN SmartV Frame Extender allows for 3 additional HYPERVSN SmartV displays M/Ls be added to standard HYPERVSN SmartV Frame which holds 6 displays. These can be used in a vertical or horizontal configuration and provide the perfect spacing and alignment for the additional displays.

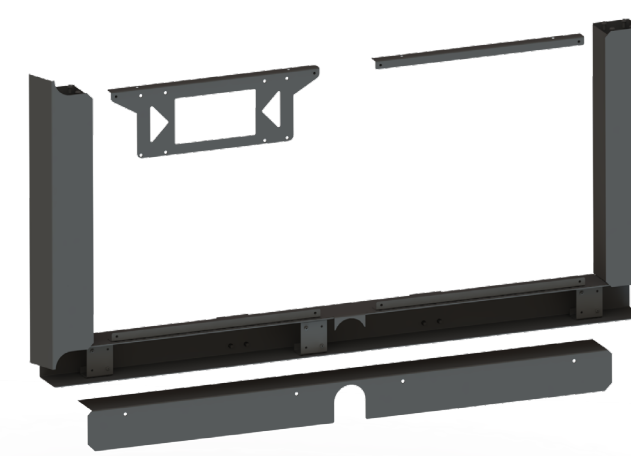

Key benefits



Extends the HYPERVSN SmartV Wall M/L to any size

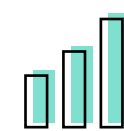

Modular in design allowing for scalability



Install, scale, and maintain with ease



Vertical and horizontal installation

Specifications

Compatibility: HYPERVSN SmartV Wall M/L

Accessory compatibility: HYPERVSN SmartV Frame and HYPERVSN SmartV Plex Guard (9/12)

HYPERVSN SmartV Frame Extender M

Weight: 11 kg / 25 lbs (w/o displays)

Dimensions: 92 cm × 48 cm × 12 cm / 36.2" × 18.9" × 4.7"

HYPERVSN SmartV Frame Extender L

Weight: 14 kg / 30.8 lbs (w/o displays)

Dimensions: 118 cm × 60 cm × 18 cm / 46.5" × 23.6" × 7.1"



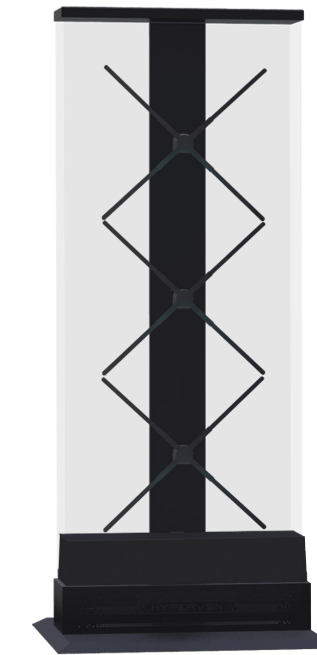

HYPERVSN SmartV Glass Box L3

This full protection installation solution is made for HYPERVSN SmartV Wall M L in a 3×1 configuration. It is perfect for displaying HYPERVSN SmartV Holographic Human or content on 3 HYPERVSN SmartV L displays arranged in a vertical configuration. The Glass Box allows the solution to be used in high traffic areas, protecting the solution and reducing the noise level.

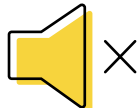

Key benefits

-  Full 360 protection
-  Reduces noise level
-  Use in high traffic areas
-  Perfect for Holographic Human

Specifications

Compatibility: HYPERVSN SmartV Wall L

Weight: 135 kg / 297.6 lbs

Dimensions: 2250 cm × 880 cm × 340 cm /
885.8" × 346.5" × 133.9"







HYPERVSN SmartV Wall Portable HH

The perfect solution to display 3D content in a vertical set-up including HYPERVSN SmartV Holographic Human. This high-quality stand provides maximum mobility and easy setup of 3 HYPERVSN SmartV L displays vertically. Display 3D content from near ground-level to 1.6 meters above the ground on this single premium stand. Use HYPERVSN SmartV Wall Portable at any event, or in a corporate or retail space, to showcase captivating 3D visuals that look like they are floating in the air.



Key benefits

-  Quick installation and assembly
-  Highly mobile with leveling wheels
-  Perfect for life-size Holographic Human display
-  Vertical display from near ground level to 1.5 meters

Specifications

Device compatibility: HYPERVSN SmartV Wall L

Weight: 28 kg / 62 lbs (w/o display)

Dimensions: 159 cm × 73 cm × 92 cm /
62.6" x 28.7" x 36.2" (w/o display)



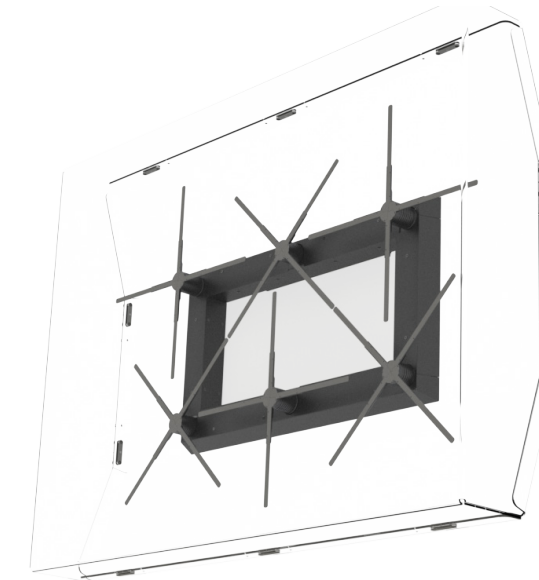

HYPERVSN SmartV Plex Guard 6

This full protection installation solution is made for HYPERVSN SmartV Wall M and L in a 3x2 configuration. It can be mounted directly onto a vertical surface (like a wall) with the included HYPERVSN SmartV Frame, while reducing the noise level, making it the perfect solution for permanent installations. HYPERVSN SmartV Plex Guard 6 will protect your display from all sides, allowing HYPERVSN SmartV Wall to be used in high traffic areas.

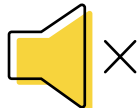

Key benefits

-  Full 360 protection
-  Reduces noise level
-  Extend the lifespan of HYPERVSN SmartV Wall
-  Perfect for high traffic areas

Specifications

Compatibility: HYPERVSN SmartV Wall M/L

HYPERVSN SmartV Plex Guard M6

Weight: 51 kg / 112 lbs

Dimensions: 159 cm × 120 cm × 32 cm /
62.6" × 47.2" × 12.6"

HYPERVSN SmartV Plex Guard L6

Weight: 80 kg / 175 lbs

Dimensions: 196 cm × 143 cm × 32 cm /
77.2" × 167.3" × 12.6"



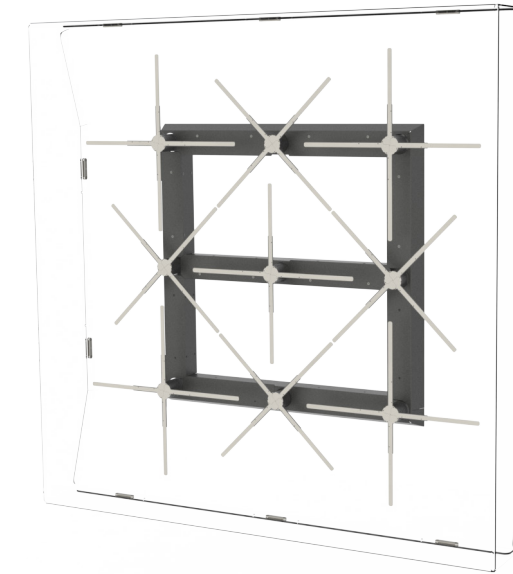

HYPERVSN SmartV Plex Guard 9

The perfect full protection installation solution for HYPERVSN SmartV Wall M and L in a 3x3 square configuration. This solution is ideal for permanent installations and can be mounted directly onto a vertical surface like a wall, using the included HYPERVSN SmartV Frame. It reduces the noise level and can be installed in high traffic areas, providing protection for your display from all sides.

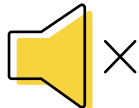

Key benefits

-  Full 360 protection
-  Reduces noise level
-  Extend the lifespan of HYPERVSN SmartV Wall
-  Perfect for high traffic areas

Specifications

Compatibility: HYPERVSN SmartV Wall M/L

HYPERVSN SmartV Plex Guard M9

Weight: 71 kg / 156 lbs

Dimensions: 159 cm × 159 cm × 32 cm /
62.6" × 62.6" × 12.6"

HYPERVSN SmartV Plex Guard L9

Weight: 110 kg / 245 lbs

Dimensions: 196 cm × 197 cm × 32 cm /
77.1" × 77.5" × 12.6"



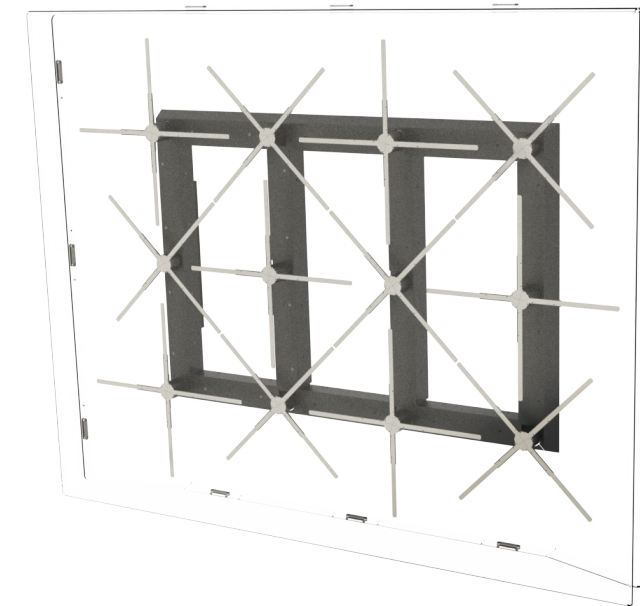

HYPERVSN SmartV Plex Guard 12

HYPERVSN SmartV Plex Guard 12 is the perfect installation solution offering full protection to HYPERVSN SmartV Wall M and L in a 3x4 setup. Mount directly onto a wall or other vertical surface using the included HYPERVSN SmartV Frame for a permanent installation. This Plex Guard can be used to reduce the noise level and is ideal for high traffic areas protecting your display from all sides.

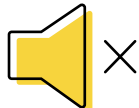

Key benefits

-  Full 360 protection
-  Reduces noise level
-  Extend the lifespan of HYPERVSN SmartV Wall
-  Perfect for high traffic areas

Specifications

Compatibility: HYPERVSN SmartV Wall M/L

HYPERVSN SmartV Plex Guard M12

Weight: 78 kg / 172 lbs

Dimensions: 159 cm × 195 cm × 32 cm /
62.6" × 76.6" × 12.6"

HYPERVSN SmartV Plex Guard L12

Weight: 140 kg / 310 lbs

Dimensions: 197 cm × 249 cm × 32 cm /
77.5" × 98" × 12.6"



HYPERVSN SmartV Rack

Looking to create Walls of epic proportions to stun your audience? HYPERVSN SmartV Rack is the perfect solution to create HYPERVSN SmartV Walls of virtually any size. Its modular design makes installation quicker and easier on any flat surface with accurate spacing for the displays. This high-quality, durable rack makes the holographic content on the HYPERVSN SmartV Wall the only focus, drawing in customers and converting sales.

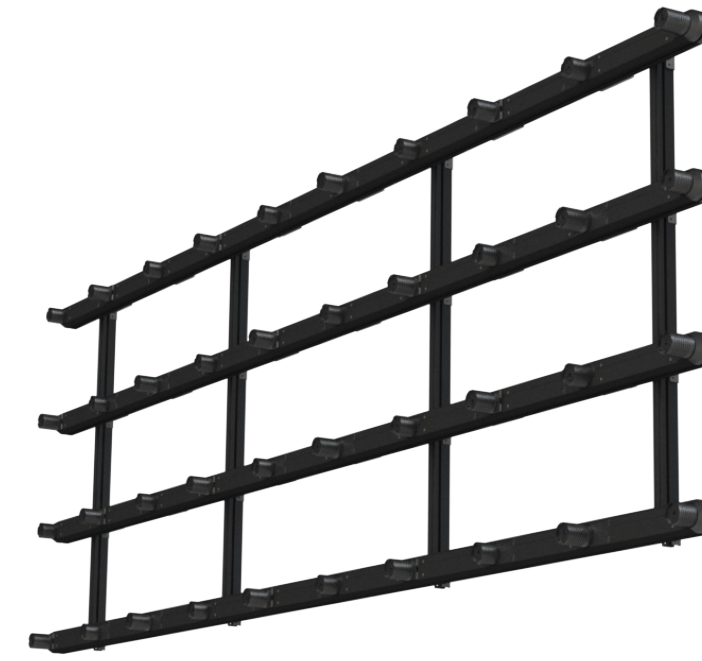

Key features



Modular design



High-quality materials



Assists with installation and maintenance

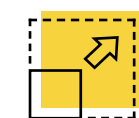

Create large scale SmartV Walls with ease



HYPERVSN SmartV Interactive Add-ons

Interactive add-ons allow you to create next-level holographic solutions to increase engagement and maximise the impact. Create holographic experiences that leave your audience speechless with innovation on another dimension.

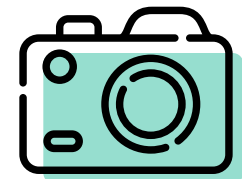

Camera based control

Display content based on the viewer's demographic (Gender, Age, Emotions, Gestures) and switch your content to target content to specific audiences maximising the impact.

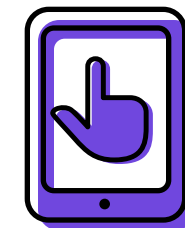

Tablet control

Allow users to control the holographic display through a tablet. Users can swipe through content like a 3D Catalogue or present 3D content in a meeting by swiping through content on the tablet.



Voice control

Display content based on voice prompts by recognizing what a customer is saying and playing the corresponding content. This allows for holographic assistants and Chatbots.



External triggers

Create next-level engagement by controlling your holographic display with external triggers like sensors (motion sensor, proximity sensor) or data from the internet (time, geography, temperature).

HYPERVSN

 Unit 12.3.1, The Leather Market,
Weston Street, London,
United Kingdom, SE1 3ER

 +44 (0) 208 0685 328
 info@hypervsn.com
 www.hypervsn.com